

UMD SHORT FORM CATALOG

sales@umd.com.au



RAM[®] MOUNTS

Issue 001

How It Works

1

Choose a Device Adapter

RAM® offers a wide selection of adapters and cradles for your specific device.

2

Choose an Arm

Select an arm based on your desired length and placement.

3

Choose a Base

Select from a variety of bases to help secure your device where you need it.



Ball Size Selection Guide



B Size

- 1" diameter ball
- Holds up to 2 lbs
- Ideal for phones, cameras and cup holders



C Size

- 1.5" diameter ball
- Holds up to 4 lbs
- Ideal for tablets and small monitors



D Size

- 2.25" diameter ball
- Holds up to 6 lbs
- Ideal for display integrations

Build a Mount

1 | Choose a Device Adapter



RAM-2461U
75mm VESA
Plate Adapter



RAM-202U
4-Hole AMPS Round
Plate Adapter



RAM-270U
Plate Adapter for John Deere
GreenStar 2630 Display



RAM-HOL-UN8BCU
RAM® X-Grip® Holder
for 7"-8" Tablets

2 | Choose an Arm



RAM-201U-B
3.56" Short Socket Arm



RAM-201U
5.69" Medium Socket Arm



RAM-201U-D
9.125" Long Socket Arm

3 | Choose a Base



RAM-235U
.75" to 1.25"
Diameter U-Bolt Base



RAM-202U
4-Hole AMPS
Drill-Down Base



RAP-365-224-1U
RAM® Twist-Lock™ Triple Suction Base



RAM-408-112-15U
1.125" to 1.5" Diameter
RAM® Torque™ Base

B Size Holders & Adapters

The RAM® X-Grip® keeps your phone secure and accessible, no matter what base it's connected to. The spring-loaded design of the RAM® X-Grip® means it can support any size phone with or without a case or sleeve. For use in high vibration environments, the RAM® X-Grip® comes with an easy-to-attach rubber tether for added security. Diamond, rectangular and round adapter plates are also available with the AMPS hole pattern.



RAM-HOL-UN7BU
RAM® X-Grip® Holder
for Phones up to 3.25" Wide



RAM-HOL-UN10BU
RAM® X-Grip® Holder
for Phones up to 4.5" Wide



RAM-B-238U
2-Hole AMPS
Diamond Plate
Adapter



RAM-B-347U
4-Hole AMPS
Rectangular Plate
Adapter



RAM-B-202U
4-Hole AMPS
Round Plate
Adapter



Seen in this photo:
RAP-B-400U,
Small RAM® Tough-Claw™
RAM-B-201U,
Medium Socket Arm
RAM-HOL-UN7BU,
Universal RAM® X-Grip® for Phones

B Size 1" Socket Arms

RAM® socket arms range from 2.42" to 6" in length and are interchangeable, allowing you to customize your mounting solution. With the RAM® Add-A-Ball™, connect another device to your existing mount with another 1" ball. Connect two arms using the RAM® Double Ball Adapter. For theft deterrence, the RAM® Pin-Lock™ Security Knob replaces the standard knob to offer added security.



RAM-B-201U-A
2.42" Short Socket Arm



RAM-B-201U
3.73" Medium Socket Arm



RAM-B-201U-C
6" Long Socket Arm



RAM-B-200-12U
RAM® Double Socket Swivel Arm



RAM-S-KNOB3U
RAM® Pin-Lock™ Security Knob Accessory

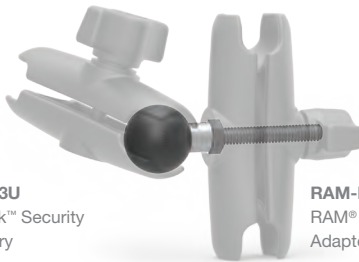

RAM-B-273U
RAM® Add-A-Ball™ Adapter Accessory



RAM-B-230U
Double Ball Adapter Accessory



Seen in this photo:
 RAM-HOL-AP19, Form-Fit Cradle for the iPhone 6 & 7 Plus
 RAM-B-238U, Diamond Ball Adapter
 RAM-B-201U, Medium Socket Arm
 RAM-B-273U, RAM® Add-A-Ball™ Accessory
 RAM-HOL-AP17U, RAM® EZ-Roll'r™ Cradle for the Apple iPad Air 1-2 & iPad Pro 9.7
 RAM-B-316-1-202U, Universal RAM® No-Drill™
 RAM® Pod™ I Vehicle Mount

B Size 1" Ball Bases

For phones, cameras and cup holders, choose from a range of B size 1" ball bases. For bases featuring AMPS hole patterns, choose between diamond, round and rectangular plates. If you need to mount to a rail, use the RAM® Torque™—available for various size rails, as well as single and double U-bolt bases. Other options include the popular RAM® Tough-Claw™ for rails, RAM® Twist-Lock™ suction cup for nonporous surfaces, and the RAM® Tough-Mag™ for magnetic surfaces.



RAM-B-238U
2-Hole AMPS Diamond
Drill-Down Base



RAM-B-202U
4-Hole AMPS Round
Drill-Down Base



RAM-B-347U
4-Hole AMPS Rectangular
Drill-Down Base



RAM-B-408-75-1U
.75" to 1" Diameter
RAM® Torque™ Base



RAM-B-408-112-15U
1.125" to 1.5" Diameter
RAM® Torque™ Base



RAM-B-231ZU
.5" to 1.25" Diameter
Single U-Bolt Base



RAM-B-235U
.75" to 1.25" Diameter
Double U-Bolt Base



RAM-B-404U
1" to 1.875" Diameter
RAM® Tough-Claw™ Base



RAM-B-224-1U
RAM® Twist-Lock™
Single Suction Cup Base



RAM-B-189B-202U
RAM® Twist-Lock™ Double Suction Cup Base



6 magnets
Max Weight 2lbs



RAM-B-MAG66U
RAM® Tough-Mag™ 66MM Diameter Base
with 1" (B) Ball



12 magnets
Max Weight 2lbs



RAM-B-MAG88U
RAM® Tough-Mag™ 88MM Diameter Base
with 1" (B) Ball



12 magnets
Max Weight 4lbs



RAM-MAG88U
RAM® Tough-Mag™ 88MM Diameter Base
with 1.5" (C) Ball

C Size Holders & Adapters

For mounting your tablet, the RAM® X-Grip® is available for tablets ranging from 7" to 12" and phones up to 4.5" wide. For large drinks and containers, the self-leveling RAM® Level Cup™ XL integrates an adjustable height feature to keep your drink in place. Whether you have a Nalgene, Pelican, Contigo or Hydro Flask, the RAM® Level Cup™ XL will secure most 32oz containers.



RAM-HOL-UN7BCU
RAM® X-Grip® Holder for Phones
up to 3.25" Wide



RAM-HOL-UN10BCU
RAM® X-Grip® Holder for Phones
up to 4.5" Wide



RAM-HOL-UN8BCU
RAM® X-Grip® Holder for 7"-8" Tablets



RAM-HOL-UN9U
RAM® X-Grip® Holder for 9"- 10" tablets
Compatible with RAM-202U ball adapter



RAM-HOL-UN11U
RAM® X-Grip® Holder for 11"- 12" tablets
Compatible with RAM-202U ball adapter



RAP-417BU
RAM® Level Cup™ XL Drink Cup Holder

C Size Holders & Adapters

Choose from a variety of adapters to secure your device, including three VESA plate adapters and one specifically for the John Deere GreenStar 2630 Display. Plate adapters with the AMPS hole pattern are available in round, diamond and rectangular versions. For cameras with a threaded post attachment, look to the RAM-202AU, RAM-202CU and RAP-379U-252025.



RAM-2461U
75mm VESA Plate Adapter



RAM-246U
100mm VESA Plate Adapter



RAM-202-225B-1U
60mm x 60mm VESA Plate Adapter
Note: RAM-202U ball is required



RAM-2462U
35mm x 75mm
VESA Plate Adapter



RAM-270U
Plate Adapter for John Deere
GreenStar 2630 Display



RAM-202U
4-Hole AMPS Round
Plate Adapter



RAM-238U
2-Hole AMPS Diamond
Plate Adapter



RAM-347U
4-Hole AMPS Rectangular
Plate Adapter



RAM-202U-225
2" x 2.5" Rectangular
Plate Adapter
Hole Pattern: 1.5" x 2"



RAM-202AU
1/4"-20 Camera Adapter
with Round Plate



RAM-202CU
3/8"-16 Camera Adapter
with Round Plate



RAP-379U-252025
1/4"-20 RAM® Tough-Ball™
Camera Adapter

C Size 1.5" Socket Arms

Ranging from 3.56" to 9.13" in length, C size 1.5" socket arms are interchangeable and allow you to customize your mounting solution. With the RAP-BC-201U, connect an existing B size ball to a C size ball. With the double ball adapter and triple ball adapter, connect two or three socket arms or mounts. For added security, the RAM® Pin-Lock™ security knob replaces the standard knob to offer added security.



RAM-201U-B
3.56" Short Socket Arm



RAM-201U
5.69" Medium Socket Arm



RAM-201U-D
9.13" Long Socket Arm



RAP-BC-201U
B Size to C Size Socket Arm



RAM-230U
Double Ball Adapter Accessory



RAM-289U
Triple Ball Adapter Accessory



RAP-S-KNOB5U
RAM® Pin-Lock™ Security Knob Accessory

C Size 1.5" Ball Bases

For tablets and small monitors, the C size 1.5" ball base is a great starting point. Choose from drill-down diamond, round and rectangular plates featuring the AMPS hole pattern that are ideal for tablets and small monitors, as well as U-bolt and RAM® Torque™ bases for rails. The heavy duty RAM® Twist-Lock™ Triple Suction Cup base provides a strong hold to nonporous surfaces, and the RAM® Tough-Ball™ and Threaded Ball are excellent solutions for threaded inserts, if available.



RAM-202U
4-Hole AMPS Round
Drill-Down Base



RAM-347U
4-Hole AMPS Rectangular
Drill-Down Base



RAM-238U
2-Hole AMPS Diamond
Drill-Down Base



RAM-202U-225
2" x 2.5" Rectangular
Drill-Down Base
Hole Pattern: 1.5" x 2"



RAM-111BU
6.25" x 2" Rectangular
Drill-Down Base



RAM-235U
.75" to 1.25" Diameter
U-Bolt Base



RAM-235-1U
1.25" to 1.5" Diameter
U-Bolt Base



RAM-408-75-1U
.75" to 1" Diameter
RAM® Torque™ Base



RAM-408-112-15U
1.125" to 1.5" Diameter
RAM® Torque™ Base



RAP-365-224-1U
RAM® Twist-Lock™
Triple Suction Base



RAP-379U-M812510
RAM® Tough-Ball™
Base for M8-1.25
Threaded Inserts



RAM-349U
Threaded Ball
Base for M10-1.25
Threaded Inserts

D Size 2.25" Ball Adapters

Several D size ball adapters are available for large electronics, including VESA plate adapters. Other adapters include the 2.5" round plate adapter with 4-hole AMPS pattern, the 3.68" round plate and rectangular plates with 4-hole patterns.



RAM-D-254U
2.5" Round Plate Adapter
4-Hole AMPS Hole Pattern



RAM-D-202U
3.68" Round Plate Adapter



RAM-D-202U-24
2" x 4" Rectangular Plate Adapter
1.5" x 3.5" 4-Hole Pattern



RAM-D-202U-25
2" x 5" Rectangular Plate Adapter
1.5" x 4.5" 4-Hole Pattern

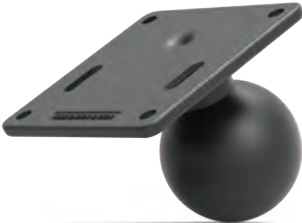

RAM-D-2461U
75mm VESA Plate Adapter



RAM-D-246U
100mm VESA Plate Adapter



RAM-D-2462U
35mm x 75mm VESA Plate Adapter

D Size 2.25" Socket Arms

D size socket arms range from 5.1" to 12.98" in length, and the double ball adapter gives you the ability to connect two socket arms. With the RAM® Hi-Torq™ wrench accessory that matches the socket arm's knob, get the tight hold you desire. For added security, check out the RAM® Pin-Lock™ security nut accessory.



D Size 2.25" Ball Bases

For display integrations, RAM® offers D size 2.25" ball bases. Choose from the 3.68" round drill-down base, the 2.5" round drill-down base with AMPS hole pattern, rectangular plate adapters with 4-hole patterns and a rectangular drill-down base. For mounting to rails from .75" to 1.5", look to the double U-bolt base.



RAM-D-202U
3.68" Round
Drill-Down Base



RAM-D-254U
2.5" Round Drill-Down Base
4-Hole AMPS Hole Pattern



RAM-D-202U-24
2" x 4" Rectangular Plate Adapter
1.5" x 3.5" 4-Hole Pattern



RAM-D-111BU
3" x 11" Rectangular Drill-Down Base



RAM-D-202U-25
2" x 5" Rectangular Plate Adapter
1.5" x 4.5" 4-Hole Pattern



RAM-D-235U
.75" to 1.25"
Diameter U-Bolt Base



RAM-D-235-1U
1.25" to 1.5"
Diameter U-Bolt Base

HOW IT WORKS

DOUBLE BALL MOUNTS

Choose from a selection of holders, socket arms and ball bases to build a custom mount for your specific needs. Additional bases may be chosen so that your mount can support multiple devices, or can be transferred to alternate mounting locations.

1

CHOOSE A BASE

Select from a variety of bases to help secure your device where you need it

2

CHOOSE AN ARM

Select an arm based on your desired length and placement

3

CHOOSE AN ADAPTER

RAM® offers a wide selection of adapters and cradles for your specific device

4

CHOOSE A HOLDER

RAM® offers a wide selection of holders for your specific device

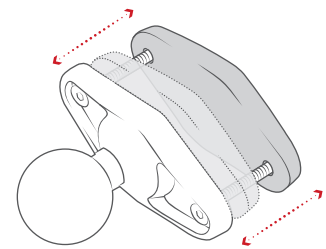

Easily adjustable

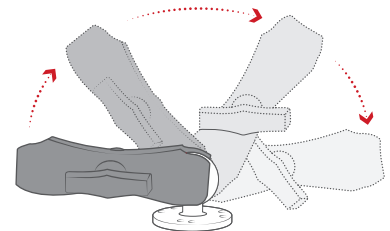

Double ball and socket technology allows for near-infinite adjustability of your RAM® mounting system

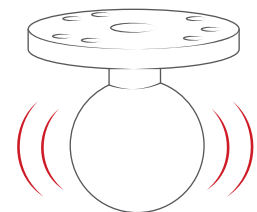
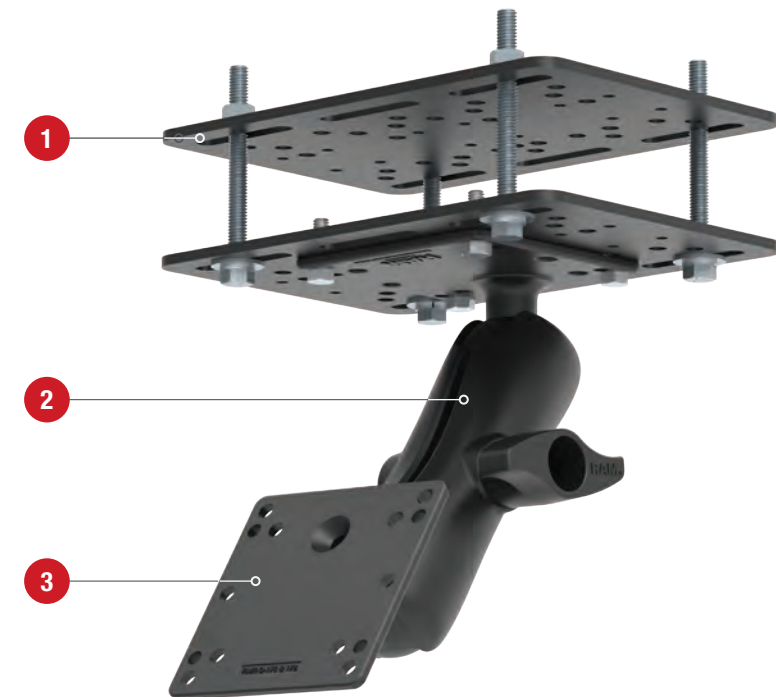

Absorbs shock and vibration

BASES

Each ball size in the RAM® Mounts rubber ball and socket system supports a different amount of weight and withstands increasingly intense vibration. Use the examples below to determine the ideal size for your system based on your device weight and application.



B SIZE

- 1" diameter ball
- Holds up to 1 lb
- Ideal for cup holders, cameras, phones, and other lightweight devices



C SIZE

- 1.5" diameter ball
- Holds up to 3 lbs
- Ideal for tablets, 2D barcode scanners, & lightweight laptops



D SIZE

- 2.25" diameter ball
- Holds up to 5 lbs
- Ideal for vehicle-mounted computers and rugged laptops in moderate vibration environments



E SIZE

- 3.38" diameter ball
- Holds up to 10 lbs
- Ideal for vehicle-mounted computers and rugged laptops in extreme vibration environments

SOCKET ARMS

RAM® Mounts feature a double ball and socket system, providing modularity and adjustability. A RAM® arm is the connection between the mounting base and your device, and are available in multiple sizes and lengths.



B SIZE 1"



C SIZE 1.5"



D SIZE 2.25"



E SIZE 3.38"

PART NUMBER	OVERALL LENGTH	SOCKET TO SOCKET	PART NUMBER	OVERALL LENGTH	SOCKET TO SOCKET	PART NUMBER	OVERALL LENGTH	SOCKET TO SOCKET	PART NUMBER	OVERALL LENGTH	SOCKET TO SOCKET
RAM-B-201U-A	2.42"	1.75"	RAM-201U-B	3.56"	2.50"	RAM-D-201U-C	5.10"	3.60"	RAM-E-201U-D	7.31"	4.97"
RAM-B-201U	3.73"	3.00"	RAM-201U	5.69"	4.66"	RAM-D-201U	8.44"	6.88"	RAM-E-201U	12.625"	9.875"
RAM-B-201U-C	6.00"	5.31"	RAM-201U-D	9.13"	8.00"	RAM-D-201U-E	12.98"	11.41"			

VEHICLE-MOUNT COMPUTER

BALL ADAPTERS C SIZE

The C Size ball will support up to 4 lbs in standard environments, and 3 lbs for heavy duty environments. "Heavy duty" environments include common forklift use.



RAM-2461U
RAM® 75x75mm VESA Plate with Ball



RAM-246U
RAM® 100x100mm VESA Plate with Ball



RAM-202U
RAM® Round Plate with Ball



RAM-243U
RAM® 50x100mm Half VESA Plate with Ball



RAM-2462U
RAM® 35x75mm VESA Plate with Ball

D SIZE

The D Size ball will support up to 6 lbs in standard environments, and 5 lbs for heavy duty environments. "Heavy duty" environments include common forklift use.



RAM-D-202U
RAM® Large Round Plate with Ball



RAM-D-246U
RAM® 100x100mm VESA Plate with Ball



RAM-D-2461U
RAM® 75x75mm VESA Plate with Ball



RAM-D-254U
RAM® Round AMPS Plate with Ball



RAM-D-2462U
RAM® 35x75mm VESA Plate with Ball



RAM-D-243U
RAM® 50x100mm Half VESA Plate with Ball

FEATURES

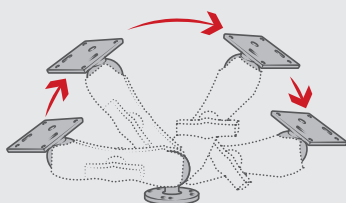
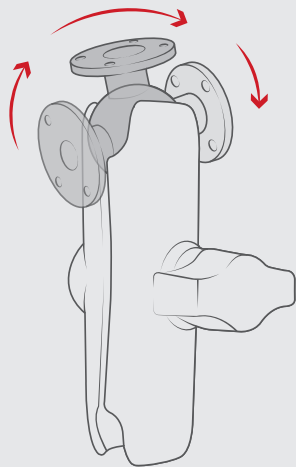

Double ball and socket technology allows for near-infinite adjustability of your RAM® mounting system

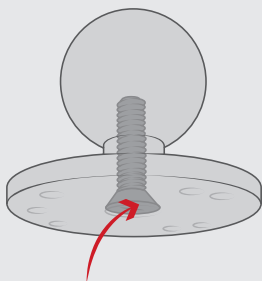

Steel bolt reinforces the post to provide maximum support even in rough environments

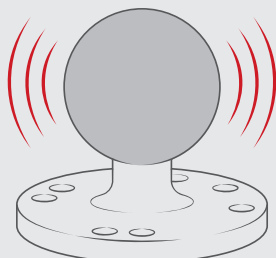

Rubber ball provides vibration damping

VEHICLE-MOUNT COMPUTER CONTINUED

**BALL ADAPTERS
STEEL REINFORCED POST**

For ball adapters with steel reinforced post, C Size ball supports 4 pounds in standard and heavy duty environments. D size ball supports 6 lbs in standard and heavy duty environments.



RAM-202U-IN1
RAM® Round Plate with Ball & Steel Reinforced Post



RAM-240U-IN1
RAM® Large Round Plate with Ball and Steel Reinforced Post



RAM-2461U-IN1
RAM® 75x75mm VESA Plate with Ball and Steel Reinforced Post



RAM-D-246U-IN1
RAM® Steel Reinforced 100x100mm VESA Plate with Ball



RAM-D-202U-IN1
RAM® Large Round Plate with Ball & Steel Reinforced Post

FEATURES

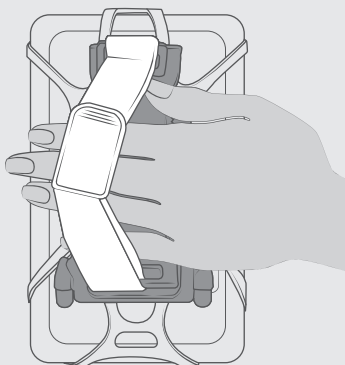

Enhances comfort and convenience for any tablet on the go

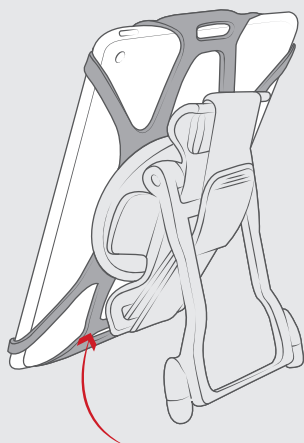

Durable rubber tether stretches around each corner of the tablet for a secure fit

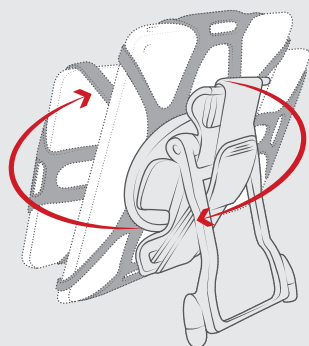

Rotates 360-degrees for landscape or portrait orientation

TABLET HOLDERS & DOCKS CONTINUED

RAM® UNIVERSAL HAND-STAND™

The RAM® Universal Hand-Stand™ is a perfect ergonomic accessory for enabling your 9"-13" tablet for field use with or without a case. The RAM® Hand-Stand™ is specifically designed to attach to any 9"-13" tablet utilizing an included durable rubber tether that stretches over each corner of the tablet. The hand strap provides a comfortable fit for a gloved hand and can be rotated 360 degrees to find the ideal viewing angle. An integrated kickstand allows for positioning the tablet on a flat surface for on the go operation of your tablet.

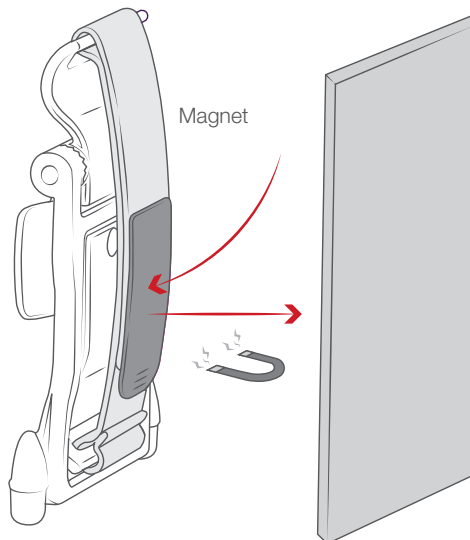

Magnetic GDS® Hand-Stand™ connects to any ferro-magnetic surface



RAM-HS1MU

RAM® Universal Hand-Stand™ for 7"-8" Tablets with Magnetic Strap



RAM-HS2MU

RAM® Universal Hand-Stand™ for 9"-13" Tablets with Magnetic Strap



RAM-HS1U

RAM® Universal Hand-Stand™ for 7"-8" Tablets



RAM-HS2U

RAM® Universal Hand-Stand™ for 9"-13" Tablets

SCANNER HOLDERS

Different types of scanner guns need different types of mounting solutions. Between the RAM® Quick-Draw™ and the RAM® Power-Grip™ we've effectively provided holders that cover a wide variety of scanner guns of different shapes and sizes. All RAM® Mounts Compatible™, these scanner gun holders have thoughtful design choices such as elastomeric fins that keep the scanner in place but also allows for quick removal of the device when you're working.



RAM-HOL-ZE9U
RAM® Quick-Draw™ Holder for Zebra TC8000/8300

RAM® POWER-GRIP™

Features replaceable elastomeric fins for a secure fit

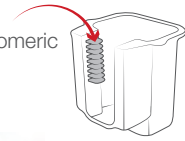

BEST SELLER

RAP-450U
RAM® Power-Grip™ XL Holder for Zebra MC9300



RAP-396U
RAM® Power-Grip™ Holder for Zebra 3600 Series

RAM® DROP-N-LOCK™



RAP-317U
RAM® Drop-N-Lock™ Scanner Gun Holder

RAM® QUICK-DRAW™



RAM-HOL-QD1U
RAM® Quick-Draw™ Spring Loaded Holder

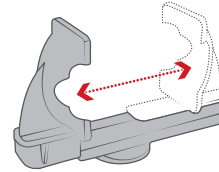

Adjustable side cups allow for supporting a wide variety of devices

SCANNER GUN COMPATIBILITY GUIDE

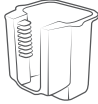
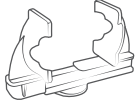
MODEL	 RAM® DROP-N-LOCK™	 RAM® POWER-GRIP™	 RAM® QUICK-DRAW™
3600 Series	-	RAP-396U	RAM-HOL-QD1U
DS8100 Series	RAP-317U	RAP-396U	-
DS4600 Series	RAP-317U	RAP-396U	-
DS2200 Series	RAP-317U	RAP-396U	-
LI2208	RAP-317U	RAP-396U	-
LI4278	RAP-317U	RAP-396U	-
LS1203	RAP-317U	RAP-396U	-
LS2208	RAP-317U	RAP-396U	-
MC2200 & 2700	RAP-317U	RAP-450U	RAM-HOL-QD1U
MC33XX Series	RAP-317U	RAP-450U	RAM-HOL-QD1U
MC3200	-	RAP-450U	RAM-HOL-QD1U
MC9200	-	RAP-450U	RAM-HOL-QD1U
MC9300	-	RAP-450U	RAM-HOL-QD1U
MT2000	-	RAP-396U	RAM-HOL-QD1U
TC8000/8300	-	-	RAM-HOL-ZE9U

SCANNER HOLDERS

Different types of scanner guns need different types of mounting solutions. Between the RAM® Quick-Draw™ and the RAM® Power-Grip™ we've effectively provided holders that cover a wide variety of scanner guns of different shapes and sizes. All RAM® Mounts Compatible™, these scanner gun holders have thoughtful design choices such as elastomeric fins that keep the scanner in place but also allows for quick removal of the device when you're working.



RAM-HOL-ZE9U
RAM® Quick-Draw™ Holder for Zebra TC8000/8300

RAM® POWER-GRIP™

Features replaceable elastomeric fins for a secure fit

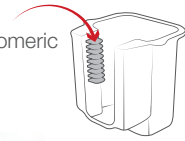

**BEST
SELLER**

RAP-450U
RAM® Power-Grip™ XL Holder for Zebra MC9300



RAP-396U
RAM® Power-Grip™ Holder for Zebra 3600 Series

RAM® DROP-N-LOCK™



RAP-317U
RAM® Drop-N-Lock™ Scanner Gun Holder

RAM® QUICK-DRAW™



RAM-HOL-QD1U
RAM® Quick-Draw™ Spring Loaded Holder

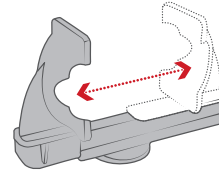

Adjustable side cups allow for supporting a wide variety of devices

SCANNER GUN COMPATIBILITY GUIDE

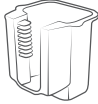
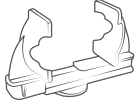
MODEL	 RAM® DROP-N-LOCK™	 RAM® POWER-GRIP™	 RAM® QUICK-DRAW™
3600 Series	-	RAP-396U	RAM-HOL-QD1U
DS8100 Series	RAP-317U	RAP-396U	-
DS4600 Series	RAP-317U	RAP-396U	-
DS2200 Series	RAP-317U	RAP-396U	-
LI2208	RAP-317U	RAP-396U	-
LI4278	RAP-317U	RAP-396U	-
LS1203	RAP-317U	RAP-396U	-
LS2208	RAP-317U	RAP-396U	-
MC2200 & 2700	RAP-317U	RAP-450U	RAM-HOL-QD1U
MC33XX Series	RAP-317U	RAP-450U	RAM-HOL-QD1U
MC3200	-	RAP-450U	RAM-HOL-QD1U
MC9200	-	RAP-450U	RAM-HOL-QD1U
MC9300	-	RAP-450U	RAM-HOL-QD1U
MT2000	-	RAP-396U	RAM-HOL-QD1U
TC8000/8300	-	-	RAM-HOL-ZE9U



SEEN IN THIS PHOTO:

- RAM-VPR-104**
RAM® Quick-Draw™ Jr. Universal Small Printer Holder
- RAM-101U-247-4**
RAM® 4" Square Post Clamp Mount with Round AMPS Plate

PRINTER HOLDERS

RAM® Mounts always doubles down on universal mounting solutions, and Zebra printers provide a convenient shape to house such mounting solutions. Our RAM® Quick-Draw™ Jr. holders utilize spring-loaded grips that extend to fit nearly any size of Zebra printers. Pair these holders with any RAM® mounting components for the ideal kit in field service and material handling spaces.

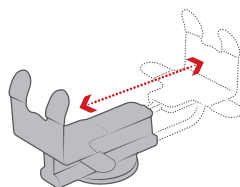

Spring-loaded universal holders offer convenient insertion and removal



RAM-VPR-105
RAM® Quick-Draw™ Jr. Universal Printer Holder



RAM-VPR-104
RAM® Quick-Draw™ Jr. Universal Small Printer Holder

MODEL	PART ID
QLN Series	RAM-VPR-104
ZQ300 Series	RAM-VPR-104
ZQ500 Series	RAM-VPR-104
ZQ600 Series	RAM-VPR-104

SEEN IN THIS PHOTO:

RAM-D-202U-CR01

Crown Work Assist Adapter with 2.25" Ball

RAM-D-201U-C

Short Socket Arm with 2.25" Ball

RAM-D-202U-23

Device Adapter with 2.25" Ball

RAM-KNOB9HU

RAM® Hi-Torq™ Wrench for 2.25" Ball

VEHICLE MOUNT COMPUTER SOLUTIONS

When it comes to heavy duty equipment, RAM® Mounts is the most trusted brand for keeping these devices mounted without fault. For large Zebra vehicle computers, take advantage of the ultra-rugged forklift and vehicle mounts with VESA ball adapters designed to install directly into the back of the computer.

1

CHOOSE A BALL ADAPTER

RAM® offers a wide selection of ball adapters and cradles for your specific device.

2

CHOOSE A SOCKET ARM

Select a socket arm based on your desired length and placement.

3

CHOOSE A BASE

Select from a variety of bases to help secure your device where you need it.



This wrench provides the extra leverage needed to tighten the mount in cold weather or in small spaces

RAM-KNOB9HU

RAM® Hi-Torq™ Wrench for D Size Socket Arms



Vibration damping

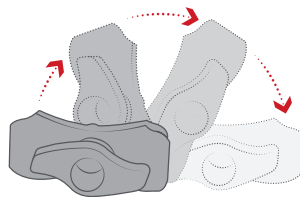

Double ball and socket technology allows for near-infinite adjustability of your RAM® mounting system

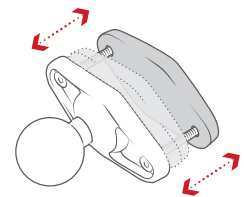

Easily adjustable



SEEN IN THIS PHOTO:

- RAM-335-D-246**
Overhead Guard Plate with 2.25" Ball
- RAM-D-201U-C**
Short Socket Arm for 2.25" Ball
- RAM-D-202U-23**
Device Adapter with 2.25" Ball

1 BALL ADAPTERS



RAM-D-2461U
75 x 75mm VESA Pattern
Zebra VC70N0



RAM-D-202U-23
1.5" x 2.5" Hole Pattern
Zebra VC8300
Zebra VC80x
Zebra VH10 / VH10F

2 SOCKET ARMS



RAM-D-201U-C
Short Socket Arm



RAM-D-201U-C-MI1
Short Socket Arm with Jam Nut



RAM-D-201U
Medium Socket Arm



RAM-D-201U-MI1
Medium Socket Arm with Jam Nut

3 BASES



RAM-D-247U-4-IN1
4" Square Clamp Forklift Base



RAM-D-202U-IN1
Drill-Down Base with Steel Reinforced Bolt



RAM-D-202U-CR01
Crown Work Assist Ball Base

UNIVERSAL HOLDERS

Using a tablet for in-vehicle navigation and mobile work is on the rise. The RAM® X-Grip® for Tablets has all the benefits and design features of the standard X-Grip® with added arm support for a variety of different size Zebra tablets with, or without a rugged case. Additional grip handles provide side support for portrait, or landscape orientation, and are completely removable. Protect your investment with the highly rugged X-Grip® and be sure these holders stand the test of time in the harshest environments.



**BEST
SELLER**

RAM-HOL-UN9U
RAM® X-Grip® Universal Holder
for 9"-10" Tablets

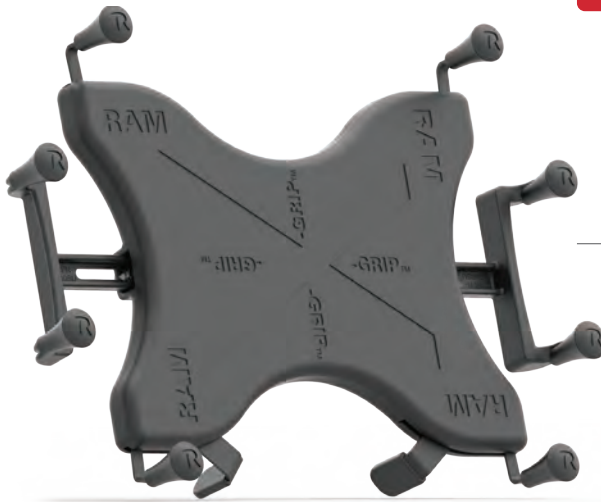

RAM-HOL-UN11U

RAM® X-Grip® Universal Holder for
11"-12" Tablets and Zebra XSLATE R12

FEATURES

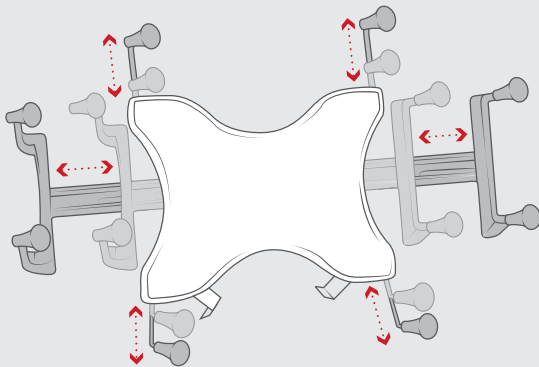

Additional grip handles for
convenient insertion and removal

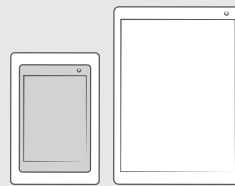

Fits all tablets with
or without a case

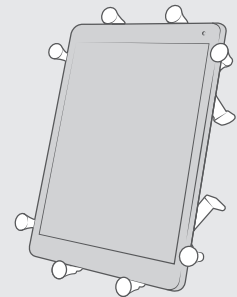

Steel spring-loaded arms
keep tablets secure

Features

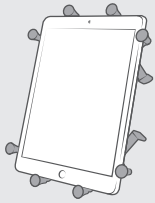

Steel, spring-loaded arms keep tablets secure

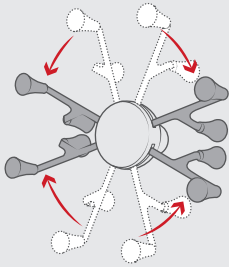

Highly adjustable to support tablets in portrait and landscape mode

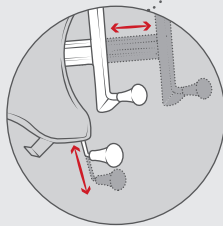
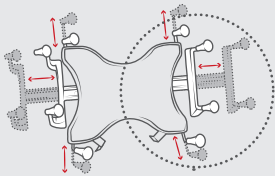

Additional grip handles for convenient insertion and removal

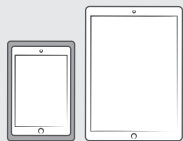

Fits all tablets 7"-12" with or without a case

Tablet Holders Continued

RAM® X-Grip®

The RAM® X-Grip® for tablets is the most durable universal holder on the market. The spring-loaded arms expand and contract to provide a perfect fit for your tablet with or without a case. Available for tablets of all sizes, the RAM® X-Grip® holder secures your device from all angles while keeping it completely functional and accessible. No matter what mounting base you pair the RAM® X-Grip® with, the RAM® ball and socket technology allows for near-infinite adjustability and extends the life of your tablet with vibration damping capabilities.



RAM-HOL-UN8BU
RAM® X-Grip® Universal Holder for 7"-8" Tablets with Ball



BEST SELLER **RAM-HOL-UN9U**
RAM® X-Grip® Universal Holder for 9"-10" Tablets



RAM-HOL-UN11U
For 11"-12" Tablets

Features

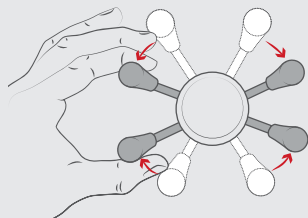

RAM® X-Grip® phone holder features an 'X' design that expands and contracts to provide a perfect fit for your device – even if it's in a case

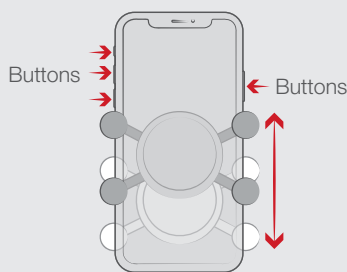

The 'X' design in RAM® X-Grip® can move up and down to expose any buttons

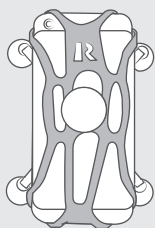
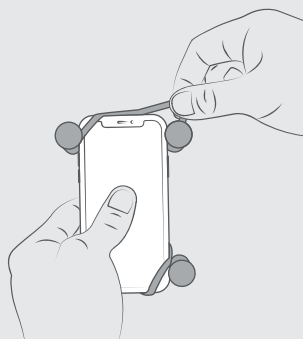

Includes safety tether for extra peace of mind

Phone Holders

RAM® X-Grip®

The RAM® X-Grip® is the most durable universal phone holder on the market. The spring-loaded arms expand and contract to provide a perfect fit for your phone with or without a case. Available for cellphones of all sizes, the RAM® X-Grip® cradle secures your device while keeping it completely functional and accessible. No matter what mounting base you pair the RAM® X-Grip® with, the RAM® ball and socket technology allows for near-infinite adjustability and extends the life of your phone with vibration damping capabilities.

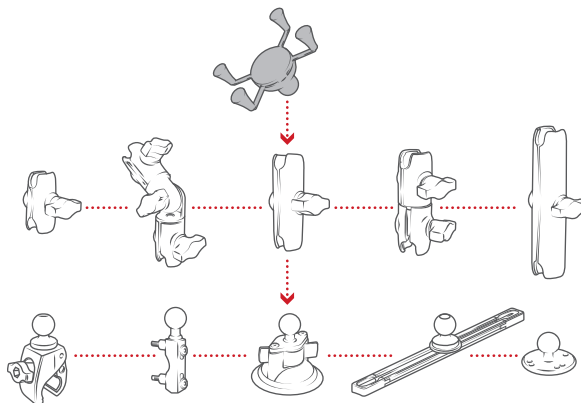

Compatible and interchangeable with a wide range of popular RAM® mounting products



RAM-HOL-UN7BU
RAM® X-Grip® Universal Phone Holder with Ball



Minimum Width: 1.875"



Maximum Width: 3.25"



BEST SELLER
RAM-HOL-UN10BU
RAM® X-Grip® Large Phone Holder with Ball

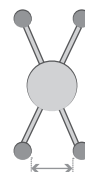

Minimum Width: 1.75"

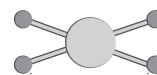

Maximum Width: 4.5"



RAM-HOL-UN4U
RAM® Finger-Grip™ for
Zebra EC30, EC50 & EC55



RAM-HOL-TABL19U
RAM® Tab-Lock™ Tablet Holder for
Zebra L10 Series (Locking)



RAM-HOL-TAB19U
RAM® Tab-Tite™ Tablet Holder
for Zebra L10 Series (Non-Locking)

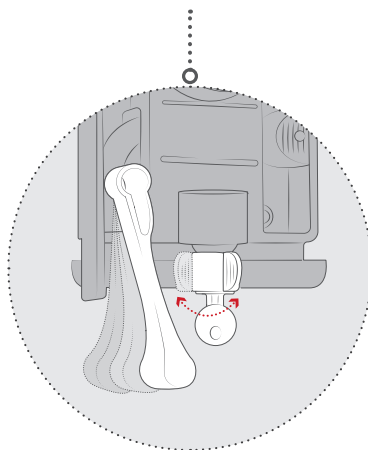

Locking mechanism for
theft deterrence

FEATURES

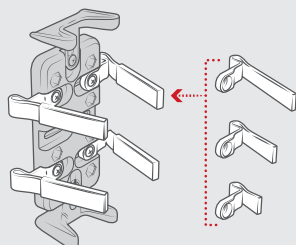

Different finger sizes to
accommodate different
device thicknesses

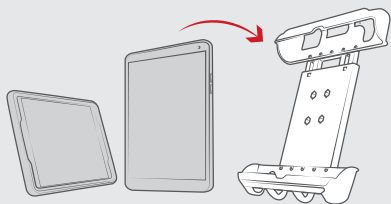

Supports tablets in portrait and landscape mode



Made of high-strength
composites for durability and
reliability in the most demanding
environments

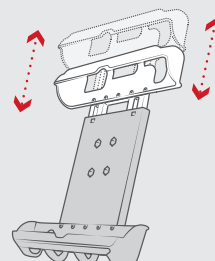

Adjustable to secure
all tablets

Features

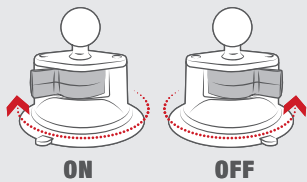

Patented RAM® Twist-Lock™ suction design

Double ball and socket technology allows for near-infinite adjustability of your RAM® mounting system

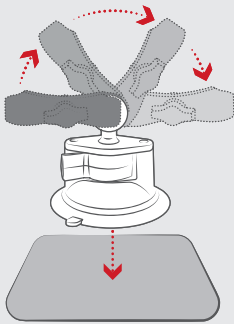

RAM-B-189B-202U
RAM® Twist-Lock™ Dual Suction Cup Base with Ball



RAM-B-189B-PIV1U
RAM® Twist-Lock™ Dual Pivot Suction Cup Base with Ball

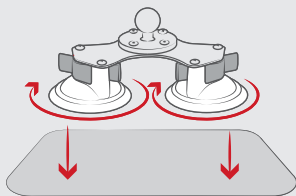

Holds strong against any windshield or non-porous surface



RAM-B-166-UN7U
RAM® X-Grip® Phone Mount with RAM® Twist-Lock™ Suction Cup



RAM-B-166-UN10U
RAM® X-Grip® Large Phone Mount w/ RAM® Twist-Lock™ Suction Cup Base

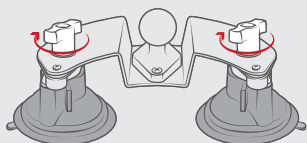

RAM-B-189B-PIV1U has the ability to independently articulate each suction cup, this mounting base can be used in a variety of applications such as curved windows and surfaces



RAM-B-166-C-UN10U
RAM® X-Grip® Large Phone Mount w/ RAM® Twist-Lock™ Suction Cup Base and Long Arm



RAM-B-166-UN8U
RAM® X-Grip® with RAM® Twist-Lock™ Suction Cup Mount for 7"-8" Tablets

Windshield Mounting RAM® Twist-Lock™ Suction Cup

The RAM® Twist-Lock™ Suction Cup has a strong hold on glass and non-porous surfaces. Pair it with your favorite action camera, or with the universal RAM® X-Grip® phone cradle for a safe and accessible solution for phones of all sizes.



**BEST
SELLER**

RAM-B-224-1U
RAM® Twist-Lock™ Suction Cup Base with Ball

DESK & TABLE MOUNTS

> PAIR ANY BASE AND SOCKET ARM WITH ANY HOLDER (PG. 13-14) **TO COMPLETE YOUR MOUNT.**

BASES No matter how you want to mount your device, there's a base that will work for you. Choose from drill-down, adhesive, suction, clamping, and magnetic solutions. Each base features a B size ball.



RAM-B-202U
2.5" Round
Drill-Down Base



RAM-B-238U
2-Hole Diamond
Drill-Down Base



RAM-B-224-1U + RAP-350-35BU
Suction Cup Base with
3.5" Adhesive Disc



RAM-B-224-1U + RAP-279BU
Suction Cup Base with
6.5" Weighted Platform Base



RAP-B-404U
RAM® Tough-Claw™
1" - 1.88" Clamp Base



RAM-B-247U-4
Flat Edge Clamp Base for
up to 4" Posts



RAM-B-202-339U + RAM-343-PU
Magnetic Ball Base with
2.5" Steel Adhesive Disc
Small devices only



RAM-B-121BU
Desk/Table Edge
Clamp Base

SOCKET ARMS Choose from three different sizes of B size double socket arms depending on your specific needs: 2.38", 3.69", or 6". Once you've selected a base and socket arm, pair with any device holder to complete your mount.



RAM-B-201U-A
2.38" Double Socket Arm



RAM-B-201U
3.69" Double Socket Arm



RAM-B-201U-C
6" Double Socket Arm

DID YOU **KNOW**

Between the three size offerings, the RAM® X-Grip® will support virtually any size tablet with or without a case or sleeve

SEEN IN THIS PHOTO:

RAM-HOL-UN9U

RAM® X-Grip® Universal Holder for 9"-10" Tablets

RAM-101U-247-4

RAM® 4" Square Post Clamp Mount with Round AMPS Plate